

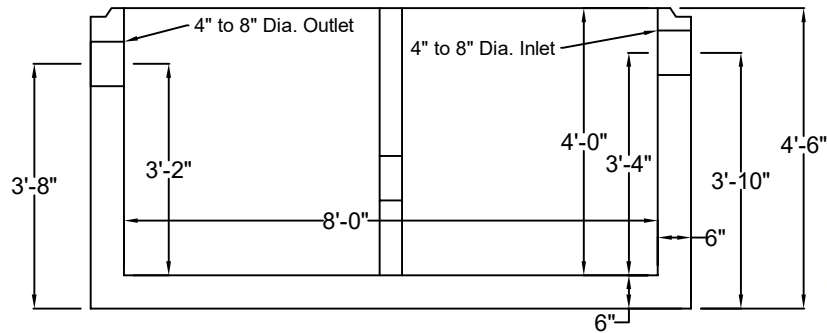

1000 gal. Grease Trap 2 Compartment H-20 Rated

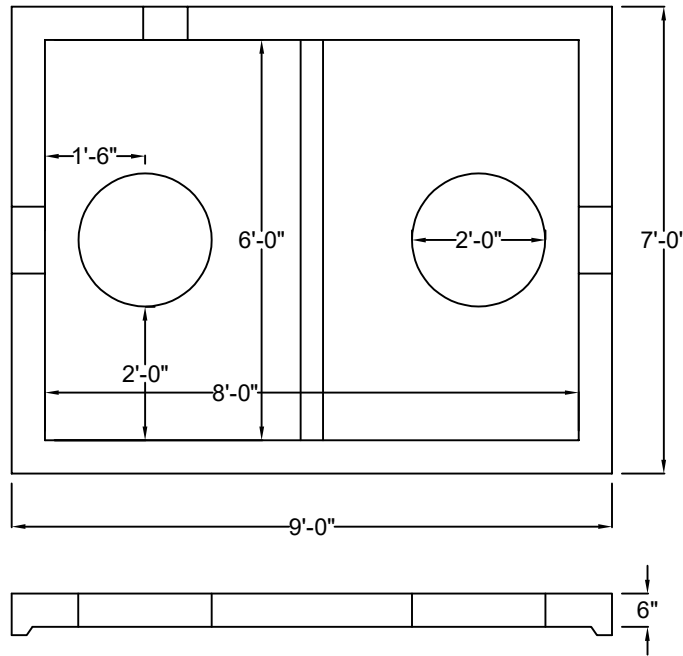

Weight: 18,900 lbs
 Heaviest Lift: 13,300 lbs

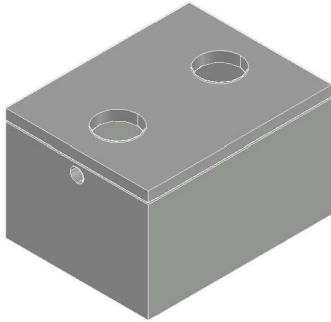

Standard Features

- 4500 PSI Concrete @ 28 Days
- Design for H-20 Traffic Loading
- Manufactured in NPCA Certified Plant

Standard Options

- Cast Iron Frame and Cover
- 1",2",3" Precast Adjustment Rings
- Pipe Inlet/Outlet Holes Where Specified
- 4" to 8" Dia. Booted Pipe Connection



T: 269-342-0539
 F: 269-344-4810
qualityprecastinc.com

7800 ADOBE RD.
 KALAMAZOO, MI