

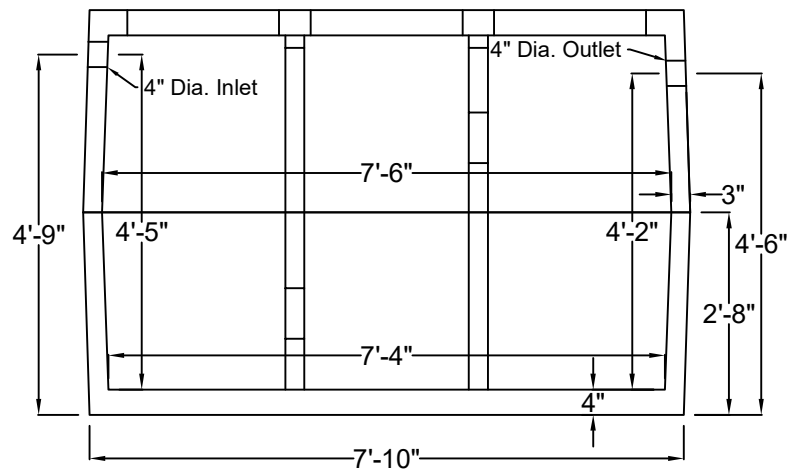

Precast Concrete 1000 gal. Grease Trap 3 Compartment

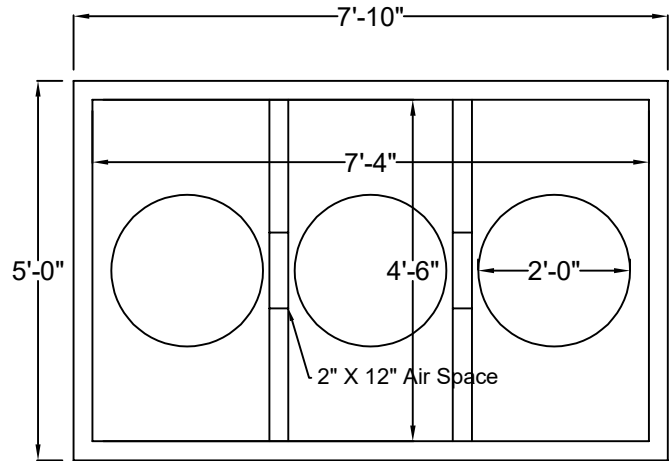

Weight: 10,200 lbs
Heaviest Lift: 4,100 lbs

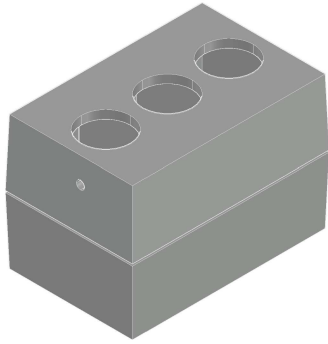

Standard Features

- 4500 PSI Concrete @ 28 Days
- Helix Steel Fiber
- Manufactured in NPCA Certified Plant

Standard Options

- Cast Iron Frame and Cover
- 1",2",3" Precast Adjustment Rings
- Pipe Inlet/Outlet Holes Where Specified
- 4" to 8" Dia. Booted Pipe Connection



T: 269-342-0539
F: 269-344-4810
qualityprecastinc.com

7800 ADOBE RD.
KALAMAZOO, MI