

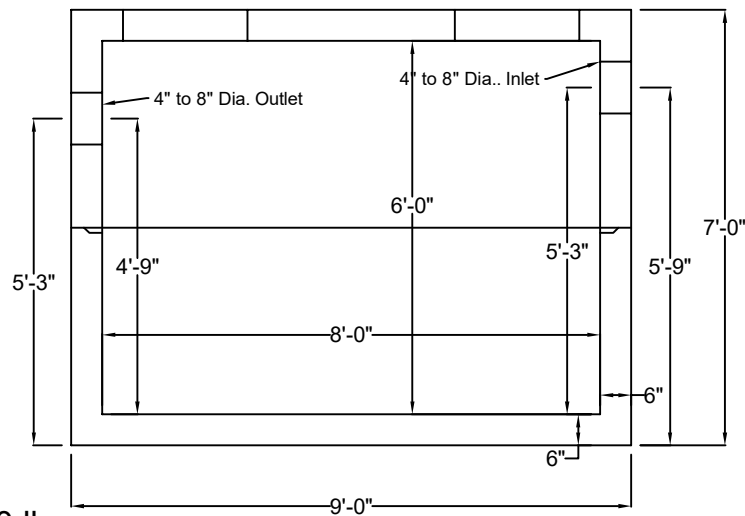

Precast Concrete 1500 gal. Septic Tank H-20 Rated

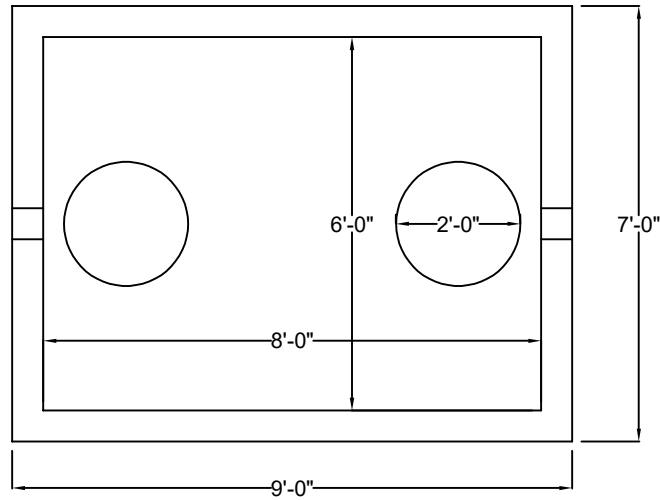

Weight: 22,100 lbs
Heaviest Lift: 11,050 lbs

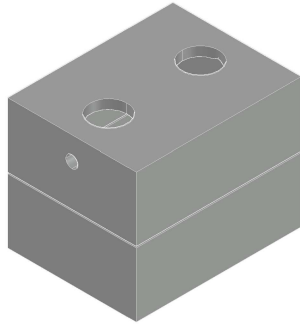

Standard Features

- 4500 PSI Concrete @ 28 Days
- Design for H-20 Traffic Loading
- Manufactured in NPCA Certified Plant

Standard Options

- Cast Iron Frame and Cover
- 1", 2", 3" Precast Adjustment Rings
- Pipe Inlet/Outlet Holes Where Specified
- 4" to 8" Dia. Booted Pipe Connection



T: 269-342-0539
F: 269-344-4810
qualityprecastinc.com

7800 ADOBE RD.
KALAMAZOO, MI