

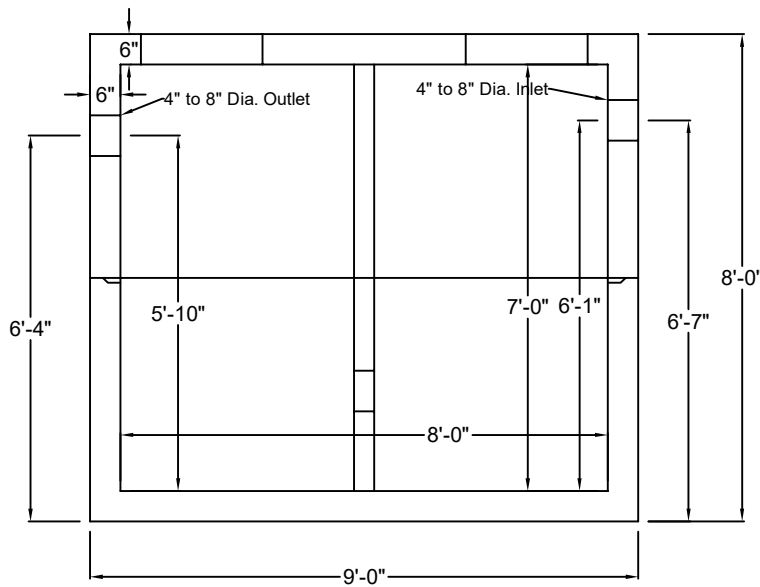

2000 gal. Grease Trap 2 Compartment H-20 Rated

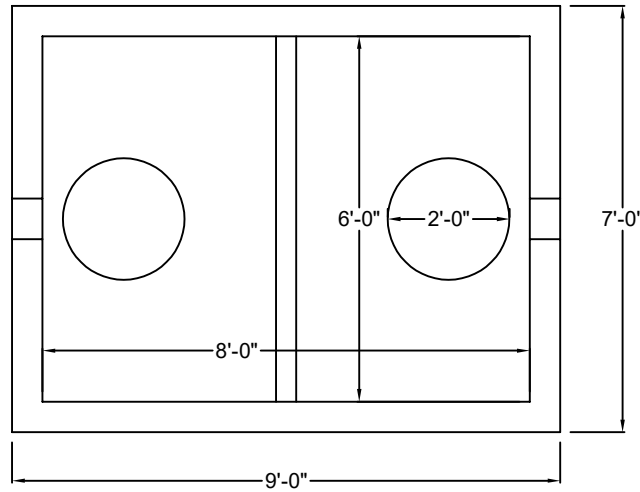

Weight: 26,600 lbs
 Heaviest Lift: 12,150 lbs

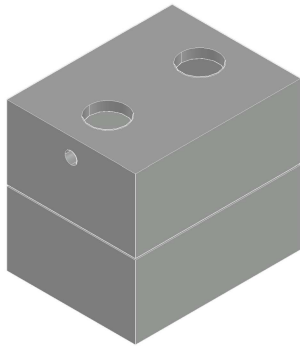

Standard Features

- 4500 PSI Concrete @ 28 Days
- Design for H-20 Traffic Loading
- Manufactured in NPCA Certified Plant

Standard Options

- Cast Iron Frame and Cover
- 1", 2", 3" Precast Adjustment Rings
- Pipe Inlet/Outlet Holes Where Specified
- 4" to 8" Dia. Booted Pipe Connection



T: 269-342-0539
 F: 269-344-4810
 qualityprecastinc.com

7800 ADOBE RD.
 KALAMAZOO, MI